

GF3545TS-1 Power Modules Schottky Rectifier

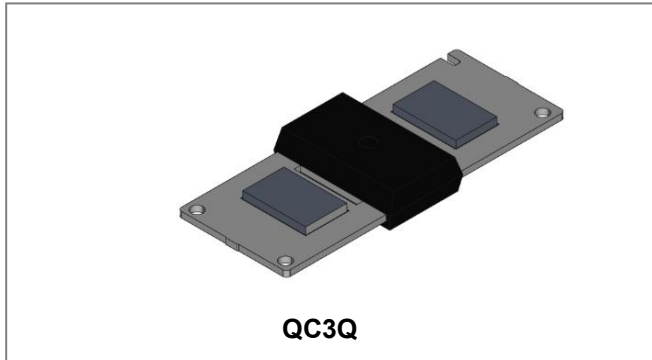

Features

- Low thermal resistance
- Lower forward voltage drop, low power loss
- Isolate Package design, ideal for heat dispersion
- High forward current capability
- Trench MOS Schottky technology
- Excellent anti-humidity
- Low profile package
- High forward surge capability
- All SMC parts are traceable to the wafer lot
- Additional electrical and life testing can be performed upon request

Mechanical Data

- Case: QC3Q
- High temperature soldering guaranteed
- Heated-tool welding 260°C, 10 seconds
- Marking Code: GF3545TS-1

Maximum Ratings(Ta=25°C Unless otherwise specified)

Characteristics	Symbol	Condition	Max.	Units
Peak Repetitive Reverse Voltage Working Peak Reverse Voltage DC Blocking Voltage	V_{RRM} V_{RWM} V_R	-	45	V
Average Rectified Forward Current	$I_{F(AV)}$	$T_C=123^\circ\text{C}$, In DC	35	A
Peak One Cycle Non-Repetitive Surge Current	I_{FSM}	8.3 ms, half Sine pulse, $T_J = 25^\circ\text{C}$	350	A
Rating for fusing ($t < 8.3\text{ms}$)	I^2t	$T_J = 25^\circ\text{C}$	500	A ² sec

Electrical Characteristics(Ta=25°C Unless otherwise specified)

Characteristics	Symbol	Condition	Typ.	Max.	Units
Forward Voltage Drop*	V_{F1}	@ 35A, Pulse, $T_J = 25^\circ\text{C}$	0.48	0.52	V
Reverse Current*	I_{R1}	@ $V_R = \text{rated } V_R$ $T_J = 25^\circ\text{C}$	0.03	0.20	mA
	I_{R2}	@ $V_R = \text{rated } V_R$ $T_J = 100^\circ\text{C}$	-	12	mA
	I_{R3}	@ $V_R = \text{rated } V_R$ $T_J = 125^\circ\text{C}$	20	55	mA
Junction Capacitance	C_T	@ $V_R = 5\text{V}$, $T_C = 25^\circ\text{C}$ $f_{SIG} = 1\text{MHz}$	5000	-	pF

* Pulse width < 300 μs , duty cycle < 2%

- China - Germany - Korea - Singapore - United States •
- <http://www.smc-diodes.com> - sales@smc-diodes.com •

Thermal-Mechanical Specifications(Ta=25°C Unless otherwise specified)

Characteristics	Symbol	Condition	Specification	Units
Junction Temperature	T_J	IN DC Forward Mode, without reverse bias, $t \leq 1$ h	-55 to +200	°C
Storage Temperature	T_{stg}	-	-55 to +150	°C
Typical Thermal Resistance Junction to Case	$R_{\theta JC}$	-	1.5	°C/W

Ratings and Characteristics Curves

Figure1 Typical Forward Characteristics

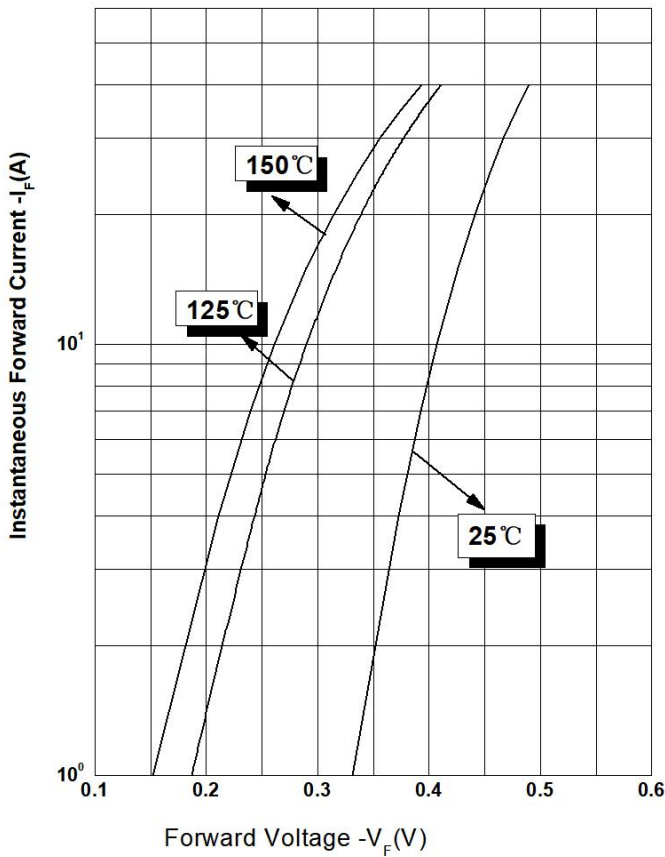

Figure 2 Typical Reverse Characteristics

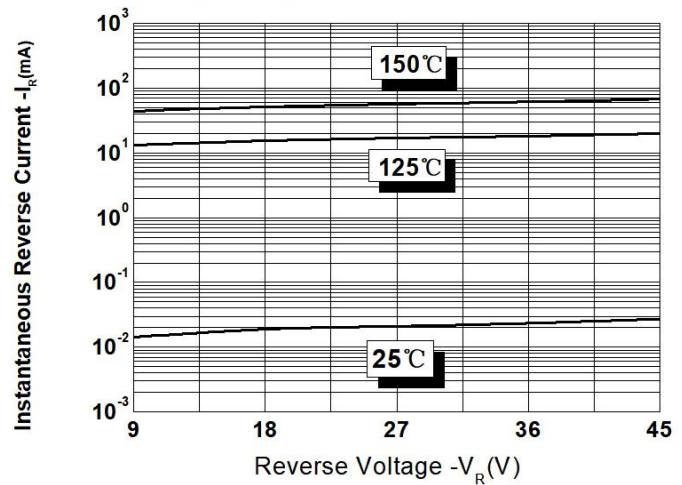
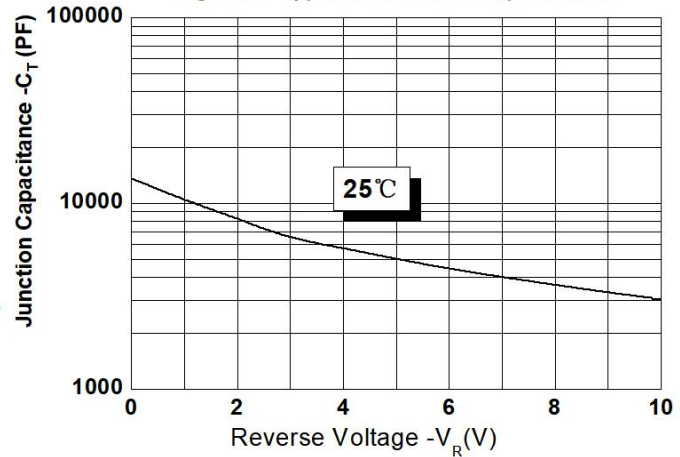

Figure 3 Typical Junction Capacitance



Technical Data
Data Sheet N2639, Rev.-

Ordering Information

Device	Package	Shipping
GF3545TS-1	QC3Q	32pcs/Tube

Marking Diagram

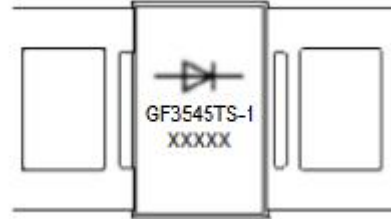

Where XXXXX is YYWWL
 GF3545TS-1 = Device Code
 YY = Year
 WW = Week
 L = Lot Number

Order P/N	Terminals	Additional
GF3545TS-1-S1	Tin Plated	None
GF3545TS-1-S2	Tin Plated	Solder Paste
GF3545TS-1-S3	Tin Plated	Solder Block
GF3545TS-1-N1	Nickel Plated	None
GF3545TS-1-N2	Nickel Plated	Solder Paste
GF3545TS-1-N3	Nickel Plated	Solder Block



Solder Paste



Solder Block

Tube Specification QC3Q (Millimeters)

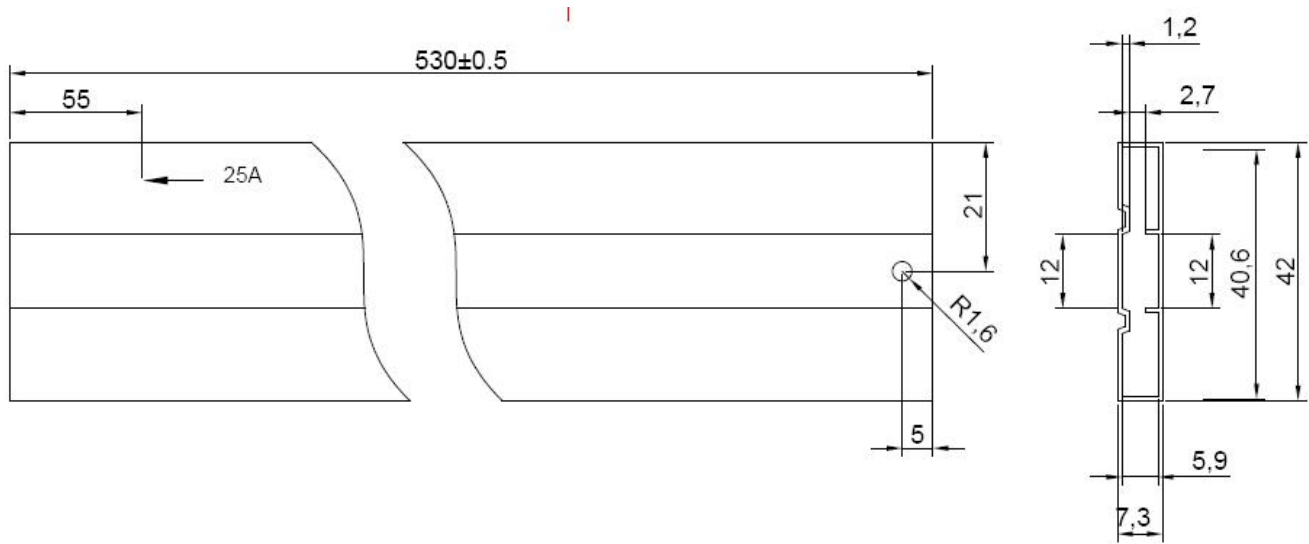

Mechanical Dimensions QC3Q (Millimeters)

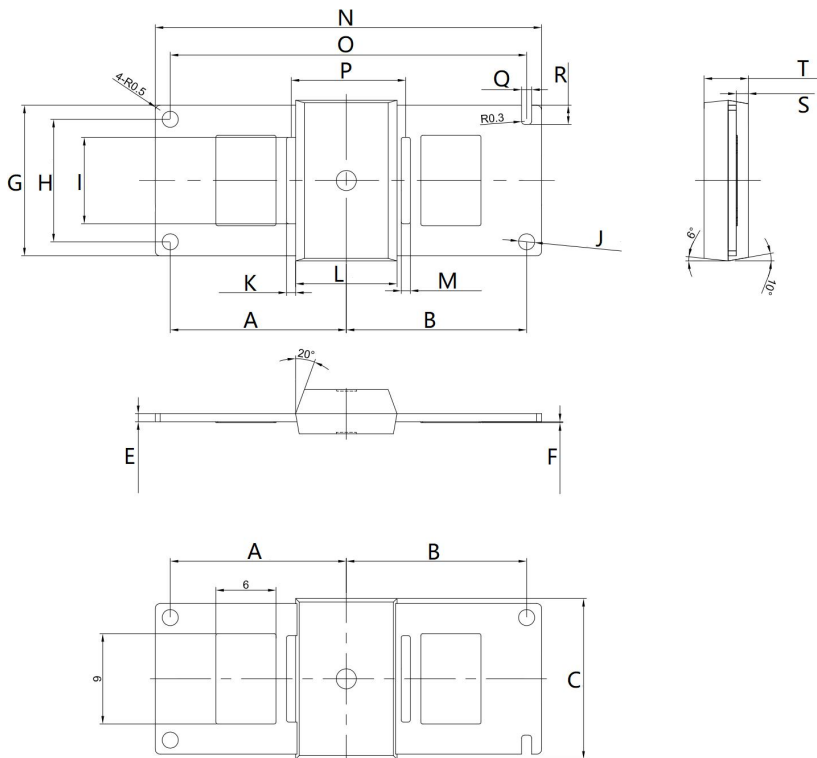

Symbol	Dimensions in millimeters		
	Min.	Typical	Max
A		17.54	
B		17.96	
C	15.90	16.00	16.10
E	0.77	0.80	0.83
F	0.08	0.10	0.12
G	14.90	15.00	15.10
H	12.15	12.20	12.25
I	8.55	8.60	8.65
J		1.60	1.70
K	0.86	0.90	0.93
L	10.00	10.10	10.20
M	0.87	0.90	0.93
N	38.40	38.50	38.60
O	35.45	35.50	35.55
P	11.32	11.42	11.52
Q		1.00	1.10
R		1.90	2.00
S	1.15	1.20	1.25
T	4.30	4.40	4.50

Technical Data
Data Sheet N2639, Rev.-

DISCLAIMER:

- 1- The information given herein, including the specifications and dimensions, is subject to change without prior notice to improve product characteristics. Before ordering, purchasers are advised to contact the SMC Diode Solutions sales department for the latest version of the datasheet(s).
- 2- In cases where extremely high reliability is required (such as use in nuclear power control, aerospace and aviation, traffic equipment, medical equipment , and safety equipment) , safety should be ensured by using semiconductor devices that feature assured safety or by means of users' fail-safe precautions or other arrangement .
- 3- In no event shall SMC Diode Solutions be liable for any damages that may result from an accident or any other cause during operation of the user's units according to the datasheet(s). SMC Diode Solution assumes no responsibility for any intellectual property claims or any other problems that may result from applications of information, products or circuits described in the datasheets.
- 4- In no event shall SMC Diode Solutions be liable for any failure in a semiconductor device or any secondary damage resulting from use at a value exceeding the absolute maximum rating.
- 5- No license is granted by the datasheet(s) under any patents or other rights of any third party or SMC Diode Solutions.
- 6- The datasheet(s) may not be reproduced or duplicated, in any form, in whole or part, without the expressed written permission of SMC Diode Solutions.
- 7- The products (technologies) described in the datasheet(s) are not to be provided to any party whose purpose in their application will hinder maintenance of international peace and safety nor are they to be applied to that purpose by their direct purchasers or any third party. When exporting these products (technologies), the necessary procedures are to be taken in accordance with related laws and regulations..